

# English

## OPERATING MANUAL

### Bath Circulators

ED-5A/B	ED-7A/B	ED-5M/B
ED-13A		ED-19A
ED-13M		ED-19M
ED-13	ED-17	ED-19
ED-27	ED-33	ED-39

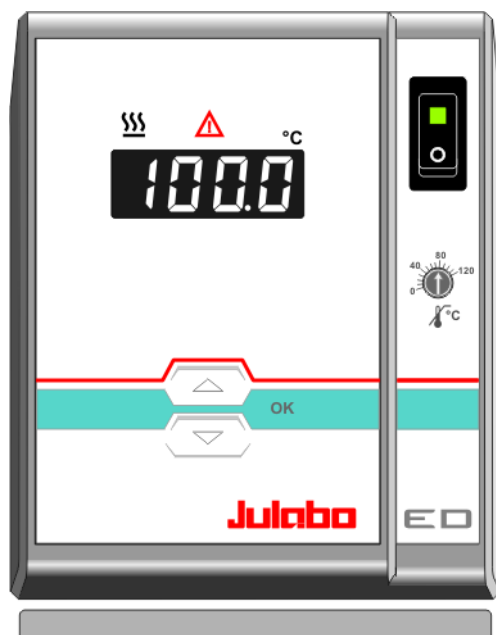

**Julabo**  
THE TEMPERATURE CONTROL COMPANY

JULABO Labortechnik GmbH  
77960 Seelbach / Germany

☎ +49 (0) 7823 / 51-0

📄 +49 (0) 7823 / 24 91

✉ [info@julabo.de](mailto:info@julabo.de)

🌐 [www.julabo.de](http://www.julabo.de)

1.951.0268

01/11

---

## **Congratulations!**

You have made an excellent choice.

JULABO thanks you for the trust you have placed in us.

This operating manual has been designed to help you gain an understanding of the operation and possible applications of our circulators. For optimal utilization of all functions, we recommend that you thoroughly study this manual prior to beginning operation.

## **The JULABO Quality Management System**



Temperature control devices for research and industry are developed, produced, and distributed according to the requirements of ISO 9001:2008. Certificate Registration No. 01 100044846

## **Unpacking and inspecting**

Unpack the circulator and accessories and inspect them for possible transport damage. Damage should be reported to the responsible carrier, railway, or postal authority, and a damage report should be requested. These instructions must be followed fully for us to guarantee our full support of your claim for protecting against loss from concealed damage. The form required for filing such a claim will be provided by the carrier.

Printed in Germany  
Changes without prior notification reserved

## TABLE OF CONTENTS

Operating manual.....	4
1. Intended use .....	4
1.1. Description.....	4
2. Operator responsibility – Safety recommendations.....	4
2.1. Disposal.....	6
2.2. EC Conformity .....	7
2.3. Warranty conditions .....	7
2.4. Technical specifications .....	8
Operating instructions .....	11
3. Safety notes for the user .....	11
3.1. Explanation of safety notes.....	11
3.2. Explanation of other notes .....	11
3.3. Safety recommendations .....	12
4. Operating controls and functional elements.....	14
5. Preparations.....	15
5.1. Installation.....	15
5.2. Bath fluids.....	16
5.3. Filling / Draining .....	17
5.4. Adjusting the pump flow.....	17
5.5. Countercooling.....	18
6. Operating procedures .....	19
6.1. Power connection .....	19
6.2. Switching on / Start – Stop.....	19
6.3. Automatic / non-automatic start mode .....	20
6.4. Setting the temperatures.....	21
6.5. Safety installations according to IEC 61010-2-010 .....	21
6.5.1. Excess temperature protection.....	21
6.5.2. Low liquid level protection .....	21
7. Troubleshooting guide / Error messages .....	22
8. Cleaning / repairing the unit .....	23

## Operating manual

### 1. Intended use

JULABO circulators have been designed to control the temperature of specific fluids in a bath tank.



JULABO circulators are not suitable for direct temperature control of foods, semi-luxury foods and tobacco, or pharmaceutical and medical products. Direct temperature control means unprotected contact of the object with the bath medium (bath fluid).

#### 1.1. Description

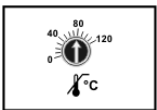
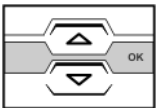

- ☑ The circulators are operated via the splash-proof keypad. The implemented microprocessor technology allows to set and to store the setpoint that can be indicated on the LED temperature display.
- ☑ The PID temperature control adapts the heat supplied to the thermal requirements of the bath.
- ☑ Safety installations conforming to IEC 61010-2-010  
The excess temperature protection is a safety installation independent from the control circuit.  
The safety value is set using a tool (screwdriver).  
If the low level protection device is triggered, a complete shutdown of the heater and circulating pump is effected.

### 2. Operator responsibility – Safety recommendations

The products of JULABO ensure safe operation when installed, operated, and maintained according to common safety regulations. This section explains the potential dangers that may arise when operating the circulator and also specifies the most important safety precautions to preclude these dangers as far as possible.

**Persons:**

The operator is responsible for the qualification of the personnel operating the units.

The operator should be constantly informed about the dangers involved with their job activities as well as preventive actions.

Make sure all persons expected to carry out operation, installation and maintenance of the unit read and understand the safety information and operating instructions.

If you have any questions concerning the operation of your unit or the information in this manual, please contact us!

**Contact** JULABO Labortechnik GmbH  
Eisenbahnstraße 45  
77960 Seelbach / Germany

Tel. +49 (0) 7823 / 51-0  
Fax +49 (0) 7823 / 24 91  
info@julabo.de  
www.julabo.de

**Handling:**

- Nevertheless, avoid strikes to the housing, vibrations, damages to the keypad foil (keys, display) or contamination.
- Make sure the product is regularly checked for proper condition.
- Regularly check (at least every 2 years) the proper condition of the mandatory, warning, prohibition and safety labels.
- Take care that the mains supply features a low impedance to avoid any negative affects on the instrument being operated in the same mains.
- This unit is designed for operation in a controlled electromagnetic environment. This means that transmitting devices (e.g. cellular phones) should not be used in the immediate vicinity.  
Magnetic radiation may influence other units with components susceptible to magnetic fields (e.g. a monitor). We recommend to keep a minimum distance of 1 m.
- Permissible ambient temperature: max. 40 °C, min. 5 °C.
- Permissible relative air humidity: 50 % (40 °C).
- Do not store in an aggressive atmosphere. Protect from contaminations.
- Do not expose to sunlight.

**Appropriate operation:**

Only qualified personnel is authorized to perform configuration, installation, maintenance and repairs of the circulator.

Routine operation can also be carried out by untrained personnel who should however be instructed by trained personnel.

**Use:**



The bath may **not** be filled with flammable materials. Fire hazard!

Only use recommended materials (bath fluids). Only use recommended materials (bath fluids).

Only use non-acid and non corroding materials.

## Operator responsibility – Safety recommendations

When using hazardous materials or materials that could become hazardous, **the operator must** affix the enclosed safety labels (**1 + 2**) to the front of the unit so they are highly visible:

1		Warning label W00: Colors: yellow, black Danger area. Attention! Observe instructions. (operating manual, safety data sheet)
2		Mandatory label M018: Colors: blue, white Carefully read the user information prior to beginning operation. <b>Scope: EU</b>
or		
2		Semi S1-0701 Table A1-2 #9 Carefully read the user information prior to beginning operation. <b>Scope: USA, NAFTA</b>

Particular care and attention is necessary because of the wide operating range.  
There are thermal dangers:

Burn, scald, hot steam, hot parts and surfaces that can be touched.

	Warning label W26: Colors: yellow, black Hot surface warning. (The label is put on by JULABO)
--	---

### 2.1. Disposal

Do not dispose of the unit with household waste!

However, over the long operating period of the unit, disposal rules may change. Therefore, only qualified personnel should handle the disposal.

#### Valid in EU countries

Directive 2002/96/EC of the European Parliament and of the Council of 27 January 2003 on waste electrical and electronic equipment (WEEE).

This directive requires electrical and electronic equipment marked with a crossed-out trash can to be disposed of separately in an environmentally friendly manner.

Contact an authorized waste management company in your country.

Disposal with household waste (unsorted waste) or similar collections of municipal waste is not permitted!

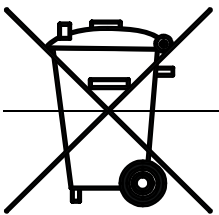

## 2.2. EC Conformity



The products described in the operating instructions conform to the requirements of the following European guidelines:

Directive of the European Parliament and of the Council on the approximation of the laws of the Member States relating to machinery.

EMC guideline with respect to legal harmonization of the member countries concerning electromagnetic compatibility.

**Julabo**

JULABO Labortechnik GmbH  
Eisenbahnstr. 45  
77960 Seelbach / Germany

## 2.3. Warranty conditions

JULABO Labortechnik GmbH warrants its products against defects in material or in workmanship, when used under appropriate conditions and in accordance with appropriate operating instructions

**for a period of ONE YEAR.**

**Extension of the warranty period – free of charge**

**2 Years Warranty**

**1Plus Warranty**

**Registration free of charge on [www.julabo.de](http://www.julabo.de)**

With the '1PLUS warranty' the user receives a free of charge extension to the warranty of up to 24 months, limited to a maximum of 10 000 working hours.

To apply for this extended warranty the user must register the unit on the JULABO web site [www.julabo.de](http://www.julabo.de), indicating the serial no. The extended warranty will apply from the date of JULABO Labortechnik GmbH's original invoice.

JULABO Labortechnik GmbH reserves the right to decide the validity of any warranty claim. In case of faults arising either due to faulty materials or workmanship, parts will be repaired or replaced free of charge, or a new replacement unit will be supplied.

Any other compensation claims are excluded from this guarantee.

## 2.4. Technical specifications

		ED
Temperature selection		digital
Temperature indication		LED
Resolution	°C	0.1
Temperature control		PID1
Heater wattage (at 230 V)	kW	2,0
Heater wattage (at 115V)	kW	1,0
Circulating pump:		
discharge, max.at 0 bar	l/min	15
pressure, max. at 0 l	bar	0.35
Ambient temperature	°C	5 ... 40
Mains power connection 230 V/50 Hz	V/ Hz	190-253 / 50
Current input (at 230 V)	A	9
Mains power connection 230 V/60 Hz	V/ Hz	190-253 / 60
Current input (at 208 V / 230 V)	A	8 / 9
Mains power connection 115 V/60 Hz	V/ Hz	103-127 / 60
Current input (at 115 V)	A	9
Mains power connection 100 V/50-60 Hz	V/ Hz	90-110 / 50-60
Current input (at 100 V)	A	9

All measurements have been carried out at:

rated voltage and frequency                      operating temperature: 70 °C

ambient temperature: 20 °C                      bath fluid: water

Technical changes without prior notification reserved.

Bath circulators with bath tanks made of		ED-5A/B Plexiglas <sup>®</sup>	ED-7A/B Plexiglas <sup>®</sup>	ED-5M/B Makrolon <sup>®</sup>
Working temperature range		20 ... 60	20 ... 60	20 ... 100
Temperature stability		±0,03	±0,03	±0,03
Bath opening (WxL)	cm	12x24	12x34	12x24
Bath depth	cm	15	15	15
Filling volume	liters	3,5 ... 5	5 ... 7	3,5 ... 5
Overall dimensions (WxDxH)	cm	14x40x34	14x50x34	14x40x34
Weight	kg	5,3	5,6	5,2

Bath circulators with bath tanks made of		ED-13A Plexiglas <sup>®</sup>	ED-19A Plexiglas <sup>®</sup>	
Working temperature range		20 ... 60	20 ... 60	
Temperature stability		±0,03	±0,03	
Bath opening (WxL)	cm	18x30	36x30	
Bath depth	cm	15	15	
Filling volume	liters	8 ... 13	12 ... 19	
Overall dimensions (WxDxH)	cm	41x33x36	55x33x36	
Weight	kg	7,5	8,5	

Bath circulators with bath tanks made of		ED-13M Makrolon <sup>®</sup>	ED-19M Makrolon <sup>®</sup>	
Working temperature range		20 ... 100	20 ... 100	
Temperature stability		±0,03	±0,03	
Bath opening (WxL)	cm	18x30	36x30	
Bath depth	cm	15	15	
Filling volume	liters	8 ... 13	12 ... 19	
Overall dimensions (WxDxH)	cm	41x33x37	55x33x37	
Weight	kg	7,5	8,5	

Bath circulators Stainless steel bath tanks		ED-13	ED-17	ED-19
Working temperature range		20 ... 100	20...100	20 ... 100
Temperature stability		±0,03	±0,03	±0,03
Bath opening (WxL)	cm	18x30	18*30	36x30
Bath depth	cm	15	20	15
Filling volume	liters	8 ... 13	14...17	14 ... 19
Overall dimensions (WxDxH)	cm	39x33x37	39x33x42	57x33x37
Weight	kg	8,0	10,0	11,0

Bath circulators Stainless steel bath tanks		ED-27	ED-33	ED-39
Working temperature range		20 ... 100	20 ... 100	20 ... 100
Temperature stability		±0,03	±0,03	±0,03
Bath opening (WxL)	cm	36x30	67x30	36x30
Bath depth	cm	20	15	30
Filling volume	liters	21 ... 27	24 ... 33	33 ... 39
Overall dimensions (WxDxH)	cm	57x33x42	91x33x38	54x34x52
Weight	kg	13,0	20,0	19,0

Safety installations according to IEC 61010-2-010:

Excess temperature protection	adjustable from 20 to 120 °C
Low liquid level protection	float switch
Classification according to DIN 12876-1	class I
Alarm indication	optical + audible (permanent)

Environmental conditions according to EN 61 010, part 1:

Use only indoor.  
 Altitude up to 2000 m - normal zero.  
 Ambient temperature: +5 ... +40 °C (for storage and transportation)  
 Air humidity:  
 Max. rel. humidity 80 % for temperatures up to +31 °C,  
 linear decrease down to 50 % relative humidity at a temperature of +40 °C  
 Max. mains fluctuation of ±10 % are permissible.

Protection class according to EN 60 529      IP21

The unit corresponds to Class I  
 Overvoltage category II  
 Pollution degree 2



**Caution:**

The unit is not for use in explosive atmosphere

Standards for interference resistance according to EN 61326-1

This unit is an ISM device classified in Group 1 (using high frequency for internal purposes)  
 Class A (industrial and commercial range).

## Operating instructions

### 3. Safety notes for the user

#### 3.1. Explanation of safety notes



In addition to the safety warnings listed, warnings are posted throughout the operating manual. These warnings are designated by an exclamation mark inside an equilateral triangle. "Warning of a dangerous situation (Attention! Please follow the documentation)."

The danger is classified using a signal word.

Read and follow these important instructions for averting dangers.



**Warning:**

Describes a **possibly** highly dangerous situation. If these instructions are not followed, serious injury and danger to life could result.



**Caution:**

Describes a **possibly** dangerous situation. If this is not avoided, slight or minor injuries could result. A warning of possible property damage may also be contained in the text.



**Notice:**

Describes a **possibly** harmful situation. If this is not avoided, the product or anything in its surroundings can be damaged.

#### 3.2. Explanation of other notes



**Note!**

Draws attention to something special.



**Important!**

Indicates usage tips and other useful information.

### 3.3. Safety recommendations

Follow the safety recommendations to prevent damage to persons or property. Further, the valid safety instructions for working places must be followed.



- Only connect the unit to a power socket with earthing contact (PE – protective earth)!
- The power supply plug serves as safe disconnecting device from the line and must be always easily accessible.
- Operation is permitted with non-flammable liquids only.
- Place the instrument on an even surface on a pad made of non-inflammable material.
- Do not stay in the area below the unit.
- Make sure you read and understand all instructions and safety precautions listed in this manual before installing or operating your unit.
- Never operate the unit without bath fluid in the bath.
- Check the filling level of the bath fluid from time to time. Pump and heater must always be fully covered with the bath fluid!
- The instrument is not suited for unsupervised continuous operation.
- Do not drain the bath fluid while it is hot!  
Check the temperature of the bath fluid prior to draining (by switching the unit on for a short moment for example).
- Observe the limited working temperature range when using plastic bath tanks.
- Employ suitable connecting tubing.  
Make sure that the tubes are securely attached.
- Never operate damaged or leaking equipment.
- Always turn off the unit and disconnect the mains cable from the power source before performing any service or maintenance procedures, or before moving the unit.
- Always empty the bath before moving the unit.
- Never operate equipment with damaged mains power cables.



- Some parts of the bath cover and the pump connections may become extremely warm during continuous operation. Therefore, exercise particular caution when touching these parts.

**Caution:**

The temperature controlling i.e. of fluids in a reactor constitutes normal circulator practice.

We do not know which substances are contained within these vessels. Many substances are:

- inflammable, easily ignited or explosive
- hazardous to health
- environmentally unsafe

i.e.: **dangerous**

**The user alone is responsible for the handling of these substances!**

The following questions shall help to recognize possible dangers and to reduce the risks to a minimum.

- Are all tubes and electrical cables connected and installed?  
Note:  
sharp edges, hot surfaces in operation, moving machine parts, etc.
- Do dangerous steams or gases arise when heating?  
Is an exhaust needed when working?
- What to do when a dangerous substance was spilled on or in the unit?  
Before starting to work, obtain information concerning the substance and determine the method of decontamination.

**Notice:**

Check the safety installations at least twice a year!

- Excess temperature protection according to IEC 61010-2-010.  
With a screwdriver turn back the adjustable excess temperature protection until the shut-down point (actual temperature).
- Low level protection according to IEC 61010-2-010.  
To check the function of the float, it can be manually lowered with a screwdriver for example.

## 4. Operating controls and functional elements

Front view

Rear view

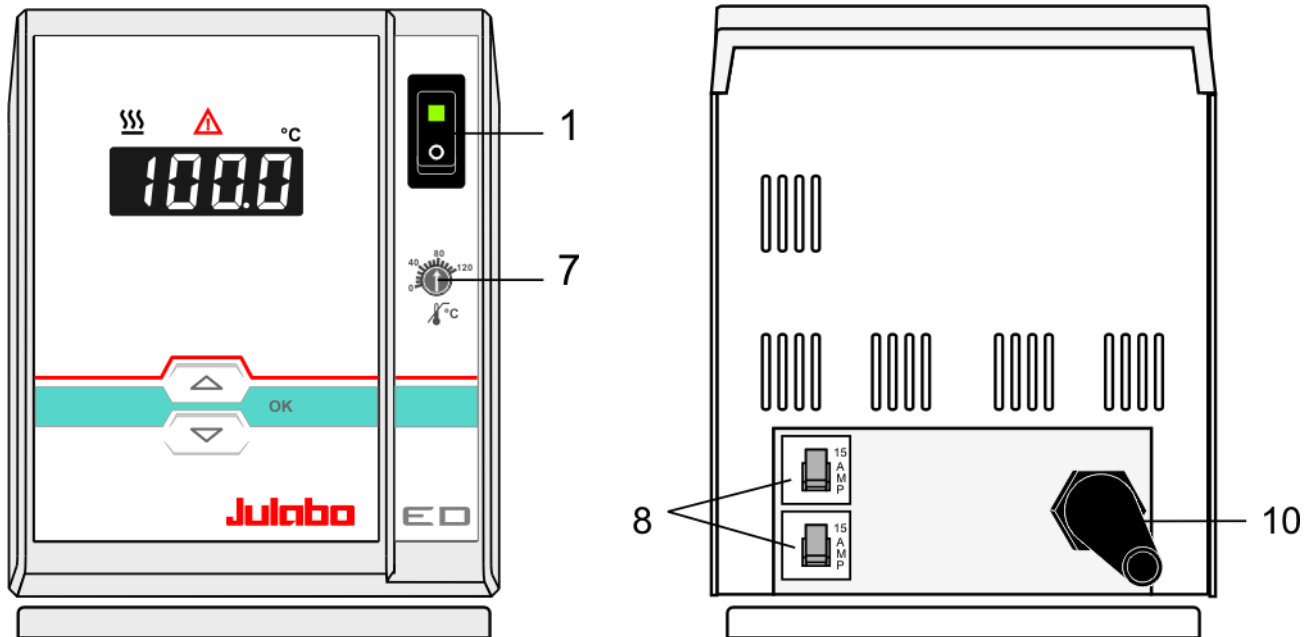



1  Mains power switch, illuminated

2  Edit keys  
Setpoint increase or decrease  
Press keys shortly for step-by-step changes,  
Keep the keys pressed for fast change of setpoint

3  OK key (store)

4  LED temperature display, menu indication

5  Control indicator –Heating

7  Control indicator – Alarm

7  Adjustable excess temperature protection  
according to IEC 61010-2-010

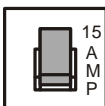
8  Circulator: Mains circuit breakers (resettable) 15 A

10  Mains power cable with plug

## 5. Preparations

### 5.1. Installation



**Notice:**

Plexiglas and Makrolon baths are not resistant to solvents.  
Avoid contamination of the bath fluid with solvents.

Top view

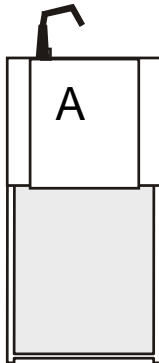

Place the circulator in an upright position.

ED-5A/B  
ED-7A/B  
ED-5M/B

The circulator (A) mounted on a stainless steel bridge is placed on the back of the bath tank.

Top view

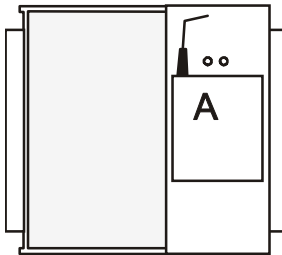

ED-13A / ED-19A, ED-13M / ED-19M

- The circulator (A) fitted with a stainless steel bridge is placed on the right side of the bath tank leaving the bath open on the left side.

Top view

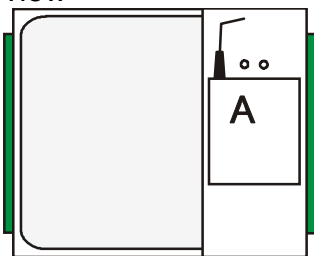

- The circulator (A) fitted with a stainless steel bridge is placed on the right side of the bath tank leaving the bath open on the left side.

ED-13, ED-17, ED-19, ED-27, ED-33, ED-39

A lift-up bath cover or flat stainless steel bath cover is available as optional accessory.

Lift-up bath cover:

Order-No. 8970253	Bath tank 13, 17
Order-No. 8970254	Bath tank 19, 27
Order-No. 8970257	Bath tank 33

Flat stainless steel bath cover:

Order-No. 8970263	Bath tank 39
Order-No. 8970290	Bath tank 13, 17
Order-No. 8970291	Bath tank 19, 27
Order-No. 8970292	Bath tank 33

## 5.2. Bath fluids



**Caution:**

No liability for use of other bath fluids!  
**Do not use flammable bath fluids!**

**Water:** The quality of water depends on local conditions.

- Due to the high concentration of lime, hard water is not suitable for temperature control because it leads to calcification in the bath.
- Ferrous water can cause corrosion - even on stainless steel.
- Chloric water can cause pitting corrosion.
- Distilled and deionized water is unsuitable. Their special properties cause corrosion in the bath, even in stainless steel.

### Recommended bath fluids:

Bath fluid	Temperature range
soft/decalcified water	5 °C to 80 °C



See website for list of recommended bath fluids.

**Contact:** see page 5



**Notice:**

Please contact JULABO before using other than recommended bath fluids.  
Only use non-acid and non corroding bath fluids.

JULABO takes no responsibility for damages caused by the selection of an unsuitable bath fluid.

Unsuitable bath fluids are liquids which e.g.

- are very highly viscous  
(much higher than 30 mm<sup>2</sup> /s at the respective working temperature)
- have corrosive characteristics or
- tend to cracking.

### 5.3. Filling / Draining



**Notice:** Filling

Check the filling level of the bath fluid from time to time. Pump and heater must always be fully covered with the bath fluid!

The instrument is **not** suited for unsupervised continuous operation.

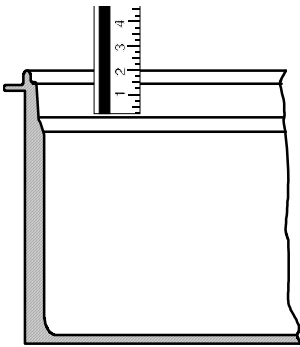

Filling

- Take care that no liquid enters the interior of the circulator.
- Recommended maximum filling level with water as bath liquid: 20 mm below the tank rim
- ① After filling, immerse the samples in the bath or place the lid on the bath, in case the opening is not to be used.

Draining

- Press the mains switch to turn the circulator off.
- Remove the circulator from the bath tank.
- Empty the bath tank.



**Notice:** Draining

Do not drain the bath fluid while it is hot!

Recommendation: Temperature range 5 °C to 40 °C

Check the temperature of the bath fluid prior to draining (by switching the unit on for a short moment, for example).

### 5.4. Adjusting the pump flow

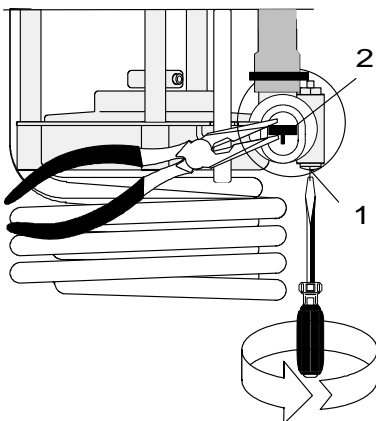

The pump flow is pre-adjusted in the factory and can be modified to suit user requirements.

- Using a screwdriver turn the screw (1) anti-clockwise by 360 °.
- Using flat pliers turn the marking of the slide (2) to the desired position.
- Tighten the screw.

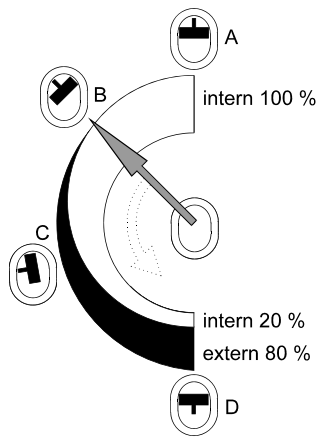

**Examples:**

Internal applications in the bath

- A 100 % internal bath circulation (for large bath tanks)
- B Reduced internal bath circulation (for smooth surface of bath fluid)

External/internal applications

- C 40 % external discharge, 60 % internal circulation (for large bath tanks)
- D 80 % external discharge, 20 % internal circulation (for small bath tanks)

**5.5. Countercooling**



**Notice:**

Observe the laws and regulations of the water distribution company valid in the location where the unit is operated.

For applications near the ambient temperature, the cooling coil must be connected to the water mains.

- Using tubing, connect the cooling coil (25a) to the tap water supply, and lead the tap water in a sink through the return connector (25b).
- ⓘ A specific water flow rate of 45 ml/minute is sufficient to compensate for the characteristic temperature.
- ⓘ For applications near ambient temperature (20 °C), the cooling water temperature should at least be 5 °C below the working temperature.

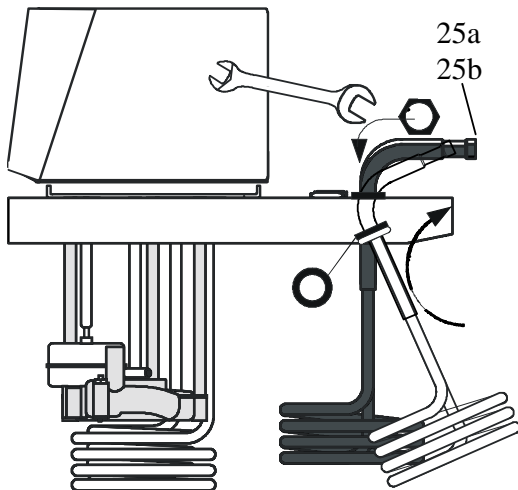

Installation cooling coil for

- ⇐ ED-13, ED-17, ED-19, ED-27, ED-33, ED-39
- ⇐ ED-13A / ED-19A / ED-13M / ED-19M

Order no. 8 970 180

Mounting the cooling coil:

Fix the cooling coil to the bridge.

**NOTE:** Immersion coolers are used for countercooling instead of tap water in applications below room temperature.

Order No.	Description
9 650 820	FT200
9 650 840	FT400
8 970 400	Clamp for cooler probe for open baths

## 6. Operating procedures

### 6.1. Power connection



#### Caution:

- Only connect the unit to a power socket with earthing contact (PE – protective earth)!
- The power supply plug serves as safe disconnecting device from the line and must be always easily accessible.
- Never operate equipment with damaged mains power cables.
- Regularly check the mains power cables for material defects (e.g. for cracks).
- We disclaim all liability for damage caused by incorrect line voltages!

Check to make sure that the line voltage matches the supply voltage specified on the identification plate.

### 6.2. Switching on / Start – Stop



#### Caution:

Observe the limited working temperature range when using plastic bath tanks.

Bath tanks made of **Plexiglas®** up to 60 °C.

Bath tanks made of **Makrolon®** up to 100 °C.

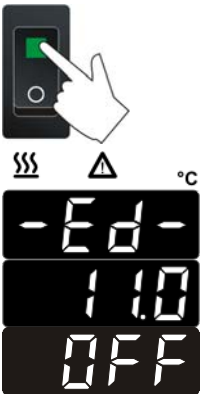

#### Switching on:

Turn the unit on with the mains power switch. (1).

- The unit performs a self-test. The segments of the 4-digit LED temperature DISPLAY and all indicator lights will illuminate (as illustrated on the left).

Then the software version (example: 11.0) appears. The display „OFF“ indicates the unit is ready to operate. (standby mode).

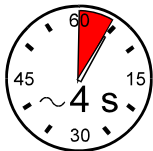

#### Start:

- Press the **OK** key for about 4 seconds.  
The LED temperature DISPLAY indicates the actual bath temperature.

#### Stop:

- Press the **OK** key for about 4 seconds.
- Turn the unit off with the mains power switch.



### 6.3. Automatic / non-automatic start mode

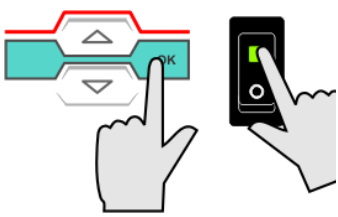

- 1 Keep depressed the **OK** key and
- 2 turn on the circulator with the mains power switch.

For a short while the LED temperature DISPLAY indicates the effective start mode:



⇒ AUTOSTART on.

⇒ AUTOSTART off.

#### NOTE:

The circulator has been configured and supplied by JULABO according to N.A.M.U.R. recommendations. This means for the start mode, that the unit must enter a safe operating state after a power failure (non-automatic start mode). This safe operating state is indicated by „OFF“ on the LED temperature display. A complete shutdown of the main functional elements such as heater and circulating pump is effected simultaneously.

Should such a safety standard not be required, the AUTOSTART function (automatic start mode) may be activated, thus allowing the start of the circulator directly by pressing the mains power switch or using a timer.



#### **Warning:**

For supervised or unsupervised operation with the AUTOSTART function, avoid any hazardous situation to persons or property.

The circulator does no longer conform to N.A.M.U.R. recommendations.





Take care you fully observe the safety and warning functions of the circulator.

The instrument is **not** suited for unsupervised continuous operation.

## 6.4. Setting the temperatures

Factory setting: 25 °C

① Setting can be carried out in the start/stop condition.

1. Press one of the keys   for a short moment. The setpoint value instead of the actual value is indicated on the display for about 8 seconds. The value can now be changed.
2. Change value:  
Press  to set a higher value.  
Press  to set a lower value.  
Keep the keys depressed for the value to change fast.
3. Press the  key to store the value.

## 6.5. Safety installations according to IEC 61010-2-010

Check the safety installations at least twice a year (see page 13)!

### 6.5.1. Excess temperature protection

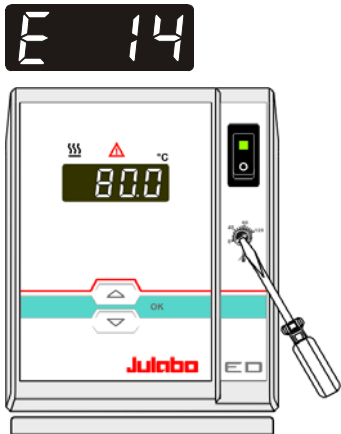

This safety installation is independent of the control circuit. When the temperature of the bath fluid has reached the safety temperature, a complete shutdown of the heater and pump is effected.

The alarm is indicated by optical and audible signals (continuous tone) and on the LED-DISPLAY appears the error message "Erro 14".

**Setting range:** 20 °C to 120 °C

- Using a screwdriver turn the setting screw to the desired value.

**Recommendation:**

**Set the excess temperature protector at 5 to 10 °C above the working temperature setpoint.**

### 6.5.2. Low liquid level protection



This safety installation is independent of the control circuit.

If the low liquid level protection device is triggered, a complete shutdown of the heater and circulating pump is effected.

The alarm is indicated by optical and audible signals (continuous tone) and on the LED-DISPLAY appears the error message "Error 01".

- ① Turn off the unit with the mains switch, refill bath fluid and turn the unit on again!

## 7. Troubleshooting guide / Error messages



Whenever the microprocessor electronics registers a failure, a complete shutdown of the heater and circulating pump is performed. The alarm light "⚠" illuminates and a continuous signal tone sounds. The LED temperature display indicates the cause for the alarm in form of a code.



Press the **OK** key to quit the audible signal.



- The circulator is operated without bath fluid, or the liquid level is insufficient.  
Replenish the bath tank with the bath fluid.
- Tube breakage has occurred (insufficient filling level due to excessive bath fluid pumped out). Replace the tubing and replenish the bath tank with the bath fluid.



- Cable of the working temperature sensor interrupted or short-circuited.



- Defect of the working or excess temperature sensor.  
Working temperature and excess temperature sensors report a temperature difference of more than 35 K.



- Error in A/D converter



- The excess temperature value lies below the working temperature setpoint.  
Set the excess temperature to a higher value.



- Cable of the excess temperature sensor interrupted or short-circuited.

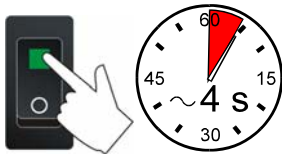

After eliminating the malfunction, press the mains power switch off and on again to cancel the alarm state.

If the unit cannot be returned to operation, contact an authorized JULABO service station.

### **Disturbances that are not indicated.**

#### Pump motor overload protection

The pump motor is protected against overloading. After a short cooling interval, the motor will automatically start running.

Circulator: Mains circuit breakers (resettable) 15 A

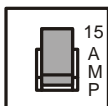

## 8. Cleaning / repairing the unit



### **Caution:**

- Always turn off the unit and disconnect the mains cable from the power source before cleaning the unit.
- Prevent humidity from entering into the circulator.
- Electrical connections and any other work must be performed by qualified personnel only.
- Plexiglas and Makrolon baths are not resistant to solvents. Do not use detergents containing alcohol or solvents.

### **Cleaning**

For cleaning the bath tank and the immersed parts of the circulator, use low surface tension water (e.g., soap suds).

Clean the outside of the unit using a wet cloth and low surface tension water.

The circulator is designed for continuous operation under normal conditions. Periodic maintenance is not required.

The tank should be filled only with a bath fluid recommended by JULABO. To avoid contamination, it is essential to change the bath fluid from time to time.

### **Repairs**

**Before asking for a service technician or returning a JULABO instrument for repair, please contact an authorized JULABO service station.**

When returning the unit:

- Clean the unit in order to avoid any harm to the service personnel.
- Attach a short fault description.
- When returning a unit, take care of careful and adequate packing.
- JULABO is not responsible for damages that might occur from insufficient packing.



JULABO reserves the right to carry out technical modifications with repairs for providing improved performance of a unit.